



# Bostik's MRO Solutions Guide

**YOUR COMPLETE REFERENCE GUIDE  
TO OUR MRO PRODUCT LINES**







# Table of Contents

**Maintenance, Repair and Operations (MRO) ..... Page 5**

**Prevent fastener loosening, leaks, backlash, corrosion and more**

Know the Basics: Inactive and Active Metals

Anaerobic Adhesives

- Threadlocking
- Pipe sealing
- Gasketing
- Retaining

**Instant Bonding ..... Page 14**

**Rapidly attach two substrates together**

One part: Bostik Instants and Born2Bond™ Instants

Two part

Dual cure

**General Bonding ..... Page 22**

**Bond a variety of substrates with ease**

Aerosol Adhesives

Glue sticks

**Structural Bonding ..... Page 26**

**Create high strength bonds between two substrates**

Pliogrip™ Polyurethane Systems

Structural Instant Adhesives

**Service Products ..... Page 28**

**Ensure effective bonding, cutting and threaded fastening to avoid manufacturing delays**

Surface Preparation: Cleaner, Activator/Booster, Primer, Gasket Remover

Lubrication: GlideCote, BladeCote

Anti-seize Compounds: Never-Seez®, Born2Bond™ Seez-Release

**MRO Equipment ..... Page 37**

**See where to use recommended products for key target devices**

Pump

Gearbox

**Bostik Trainings and Resources ..... Page 38**

**Find out how we can help serve you beyond our products**



# The Value of Working with Bostik

Bostik manufactures quality MRO bonding, anti-seize and lubricating products. Designed to be easy to use and produce consistent results, these solutions also increase operational efficiencies and improve equipment performance.

In particular, they include the following categories:



## ANAEROBIC BONDING

This product range fills the gaps where metal doesn't connect, serving as a preventive, long-term solution to many MRO equipment issues, such as vibration and corrosion or harsh environments.



## ANTI-SEIZE AND LUBRICATION

An industry standard for over 50 years, our Never-Seez®, the original anti-seize products, reduce torque and friction for easy assembly and disassembly. We also offer the industry's only lubricants for secondary woodworking applications, extending blade saw life and reducing damage to wood parts.



## INSTANT BONDING

Available in one and two-component systems, our instant engineering adhesives support long and short open time needs, making it easy to bond increasingly smaller and complex products.

## STRUCTURAL BONDING

Bostik's structural adhesives enable strong bonds across difficult and dissimilar substrates, such as metals, plastics and composites. They also maintain performance in aggressive environments and extreme conditions.

Image  
Coming  
Soon



This catalog serves as a reference guide to our MRO product lines, including how to choose and when to use our products to help eliminate unplanned downtime.



# Maintenance, Repair and Operations (MRO)

Prevent fastener loosening, leaks, backlash, corrosion and more

## Know the Basics:

### Inactive and Active Metals

If you are using inactive metals in your maintenance operations, we recommend a primer to help speed up cure rates and reduce fixture time. Refer to the list below to discern inactive from active.

#### INACTIVE METALS - PRIMER RECOMMENDED

- Plated parts
- Aluminum
- Anodized aluminum
- Titanium
- Stainless, galvanized and magnetite steel
- Nickel
- Silver
- Gold
- Zinc
- Cadmium
- Magnesium
- Natural or chemical black oxide

#### ACTIVE METALS - NO PRIMER NEEDED

- Iron
- Plain steel
- Copper
- Brass
- Bronze
- Manganese

# Anaerobic Adhesives

## Threadlocking

Bostik's Born2Bond™ threadlocking adhesives are anaerobic, single-component, liquid solutions that also are available in non-permanent, service-removable options. Unlike locking devices, they completely seal all voids and prevent corrosion. They also may protect certain equipment when subjected to vibrations, specific temperatures or particular chemical substances.

FEATURES	BENEFITS
100% uniform connection	Improved equipment component longevity
Available in multiple viscosities and strengths	Increased ability to meet diverse requirements with one product
Single-component formulation for active and passive metals	Enhanced ease of use for on-the-spot needs

## Key Applications

- Mechanical parts assembly
- Machine engineering
- Gear manufacturing
- Engines and powertrains

## Choosing the Right Thread Locking Adhesive

THREADLOCKING					
Pre-assembly			Post-assembly		
Low Strength	Medium Strength	High Strength	Removable & High Strength		
TA-22	TA-43	TA-71	TA-90		
					
					
TEMP. RANGE	-67°F to 356°F (-55°C to 108°C)			-67°F to 302°F (-55°C to 150°C)	
VISCOSITY	900 - 1,500 cps	2,500 - 3,000 cps	400 - 600 cps	20 - 55 cps	
BREAKAWAY STRENGTH	5 ft-lb	19 ft-lb	25 ft-lb	9 ft-lb	
FIXTURE TIME	20 mins.	<15 mins.	10 mins.	7 mins.	





## Best Practices

### BEFORE APPLICATION

Many product grades are oil tolerant; however, we recommend using the **Born2Bond™ pre-bonding cleaner** product to ensure a surface is 100% free from contaminants.

Be sure to thoroughly shake the bottle to properly mix its contents.

### DURING APPLICATION

An activator is not required to form a bond; however, we recommend using one on any stainless or inactive metals if you want to:

- Accelerate the cure speed or cure depth
- Apply it in cold conditions
- Apply it to a material with large gaps in between threads

When applying to a bolt housing with no nut (sometimes referred to as a “blind hole”), put a few extra threadlocking adhesive drops down the sides of the blind hole and onto the bolt threads.

Be sure to cover only the width of the nut with a threadlocking adhesive to avoid pushing the product off the threads and causing air gaps.

**Note:** These products are not recommended for use on plastics, as they can cause the plastic to stress crack.

## Pipe Sealing

Bostik's Born2Bond™ pipe sealing adhesive options are suitable for all types of threaded metal pipes and fittings for both new installation and preventive maintenance needs. These single-component products fill and seal voids, allowing them to achieve a cohesive and durable bond that may be able to withstand certain vibration, temperatures and chemical substances.

Additionally, they offer a cost-effective, long-term solution compared to traditional sealing alternatives, like hemp, pipe dope or PTFE tapes.

FEATURES	BENEFITS
100% uniform connection to mitigate corrosion, pipe leak-ages and clogged filters due to shredding	Improved equipment component longevity and worker safety
Flexible seal that accounts for thermal expansion	Reduced equipment vibration and mechanical failure
Single-component formulation suitable for active and passive metals	Enhanced ease of use for on-the-spot needs

### Key Applications

- Pumps and compressors
- Liquid and gas storage
- Hydraulic systems
- Metal pipes and fittings
- Engines and powertrains

### Choosing the Right Pipe Sealing Adhesive

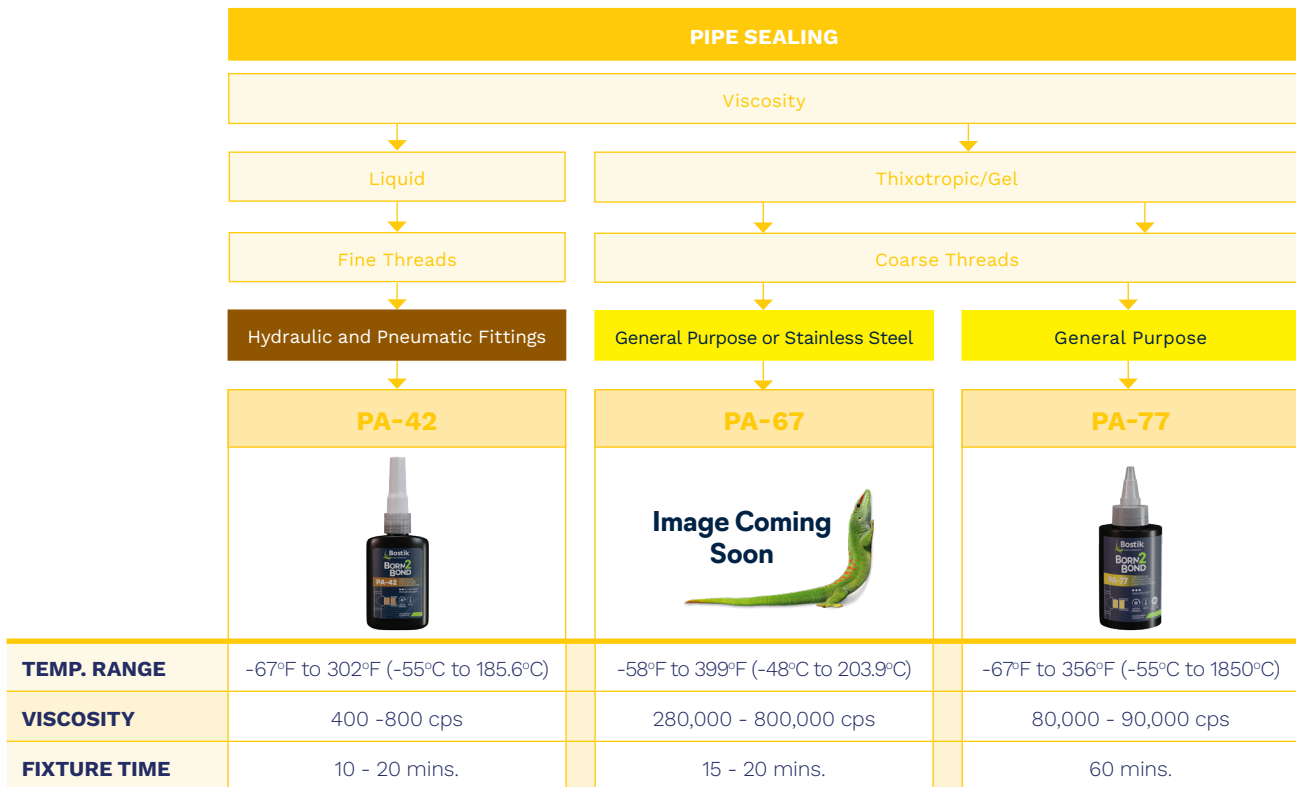





## Best Practices

### BEFORE APPLICATION

Many product grades are oil tolerant; however, we recommend using the **Born2Bond™ pre-bonding cleaner** product to ensure a surface is 100% free from contaminants before bonding to stainless and inactive metals.

Be sure to thoroughly shake the bottle to properly mix its contents.

### DURING APPLICATION

An activator is not required to form a bond; however, we recommend using one on any stainless or inactive metals if you want to:

- Accelerate the cure speed or cure depth
- Apply it in cold conditions
- Apply it to a material with large gaps in between threads

When assembling a pipe, put the pipe sealant on a few threads back instead of at the beginning. This will ensure the right amount of product gets applied without pushing off any excess and causing air gaps.

Ensure the maximum thread size does not exceed 3". If it is larger than 3", a flange connection is recommended.

## Gasketing

Bostik's Born2Bond™ gasketing adhesives are single-component alternatives to conventional, pre-formed gaskets on metal flanges. They create a flexible yet durable connection that can withstand vibration, high temperatures and exposure to oils, solvents and water. They also offer better stress distribution and, unlike traditional gaskets, do not require any “bedding-in”.

FEATURES	BENEFITS
Excellent fatigue strength and no sagging nor micro-movements	Enhanced cohesive structure
100% uniform connection to mitigate corrosion and equipment vibration	Improved equipment component longevity
Instant and flexible seal options	Increased design options

### Key Applications

- Pumps and compressors
- Liquid and gas storage
- Gearboxes and transmissions
- Engines and powertrains

### Choosing the Right Gasketing Adhesive



\* 12 hours to reach full cure when unprimed. Use primer for quicker cure of up to 2 hours.



## Best Practices

### BEFORE APPLICATION

Many product grades are oil tolerant; however, we recommend using the **Born2Bond™ pre-bonding cleaner** product to ensure a surface is 100% free from contaminants before bonding to stainless and inactive metals.

Use the **Born2Bond™ Adhesive and Gasket Remover** to avoid damage when removing previous gaskets or cured instant gaskets and to ensure a clean surface.

Be sure to thoroughly shake the bottle to properly mix its contents.

### DURING APPLICATION

An activator is not required to form a bond; however, we recommend using one on any stainless or inactive metals if you want to:

- Accelerate the cure speed or cure depth
- Apply it in cold conditions
- Apply it to a material with large gaps in between flanges

Apply the adhesive evenly in a constant bead or spray on large areas with a roller to ensure proper coverage

Choose a liquid or adhesive gasket over a physical, pre-cut gasket to form a consistent seal that doesn't get worn or bent and to reduce gasket inventory.

## Retaining

Bostik's Born2Bond™ anaerobic, retaining adhesives are a cost-effective, adaptable alternative or addition to traditional mechanical retaining processes. These single-component solutions seal all metal joints to reduce fretting corrosion risk and can bond a variety of cylindrical assemblies.

FEATURES	BENEFITS
Resistance to dynamic loads, vibration and corrosion	Increased durability
Various viscosity and strengths	Heightened application freedom
Designed for both active and passive metals	Enhanced universal use

### Key Applications

- Gear manufacturing
- Machine engineering
- Bearing assembly
- Drive shafts
- Conveyor belts
- Centrifuges
- Turbines

### Choosing the Right Retaining Adhesive

RETAINING					
	Gap fill up to 0.1mm	Gap fill up to 0.15mm	Gap fill up to 0.2mm	Gap fill up to 0.5mm	Gap fill up to ?
	Press Fit Application	Press Fit Application	Slip Fit Application	Slip Fit Application	?
	Medium Strength	High Strength	High Strength	High Strength	?
	<b>RA-41</b>	<b>RA-48</b>	<b>RA-38</b>	<b>RA-60</b>	<b>RA-20</b>
					
<b>VISCOSITY</b>	400 - 800 cps	400 - 600 cps	2,000 - 3,000 cps	400 - 800 cps	5,000 - 12,000 cps
<b>TEMP RANGE</b>	-67°F to 302°F (-55°C to 150°C)	-67°F to 356°F (-55°C to 180°C)	-67°F to 356°F (-55°C to 180°C)	-67°F to 302°F (-55°C to 150°C)	-67°F to 446°F (-55°C to 230°C)
<b>SHEER STRENGTH</b>	3,771 psi	-	3,626 psi	2,611 psi	>20 psi
<b>FIXTURE TIME AT 68°F (20°C)</b>	20-30 min. (no activator). <5 min. (with activator)	15-20 min. (no activator) <10 min. (with activator)	<10 min. (no activator) <5 min. (with activator)	10-15 min. (no activator) <5 min. (with activator)	60 min. (no activator) <15 min. (with activator)
<b>GAP FILL</b>	0.1 mm	0.15 mm	0.2 mm	0.5 mm	0.2 mm

All of these retaining, anaerobic adhesives are a cost effective, adaptable alternative to or addition to mechanical retaining processes. For specific product details, consult the product TDS.

## Best Practices

For wallowed key ways, choose RA-60 to help weld in until able to properly repair it. This is because it thicker and offers a larger gap fill than other products.

For new key ways and key stock assembly, choose TA-43 Medium Strength Threadlocker due to ideal viscosity and easy availability for the application. Apply the product on the bottom of the key way give extra strength between the key way and stock.

### BEFORE APPLICATION

Ensure surface is free from dust and contaminants.

### DURING APPLICATION

If applying in cold conditions (below 41°F/5°C), consider using a primer to help with cure speed and depth.

With a slip fit, apply the adhesive to the inner diameter and shaft to ensure you get coverage for when you put it together. This will help with the cure, because it has a larger gap than a press fit.

With a press fit, heat up one side of it at a time to control expansion and contraction. Then, apply the retaining compound to the heated side to create a tight fit

Here are diagrams to show where the retaining compound goes:

Retaining Compound:  
RA-60

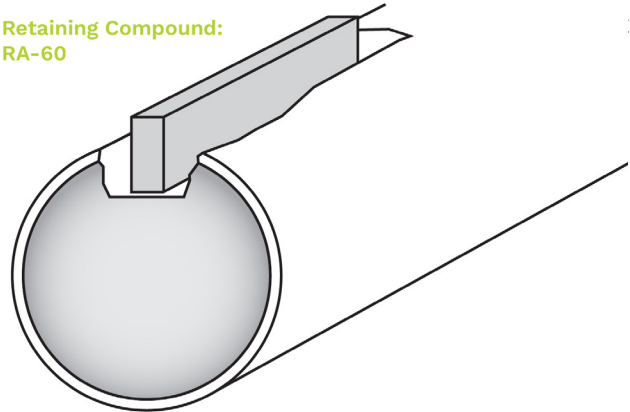

Diagram 1: Slip fit/press fit bearing on a shaft

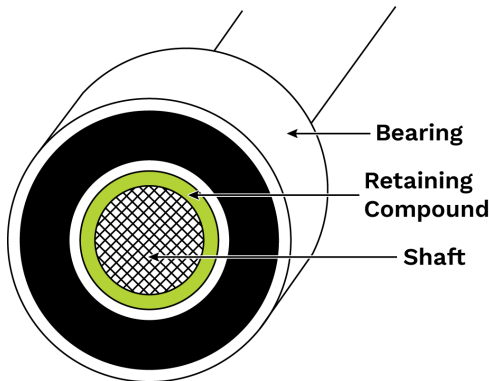

Diagram 2: Slip fit for housing component

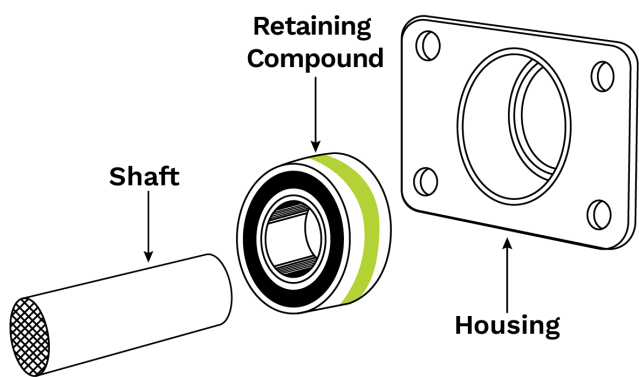
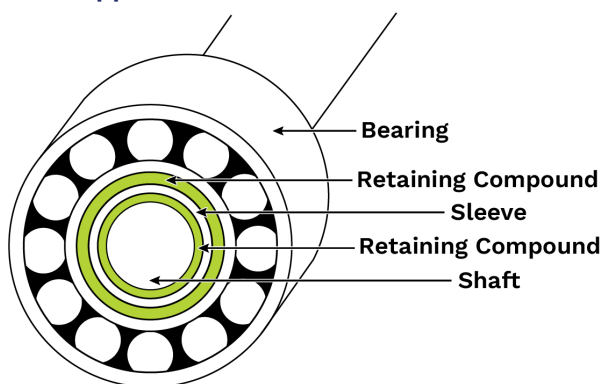

Diagram 3: Shaft mounted assembly with sleeve application





# Instant Bonding

Rapidly attach two substrates together

## Bostik Instants and Born2Bond™ Instants

Our instant engineering adhesives are available in standard as well as low blooming and odor systems depending on application requirements. They maintain a high bond strength even when subject to flexing and offer fast fixture time (10 seconds depending on gaps and substrates). Additionally, these products are designed for bonding most substrates, including low surface energy substrates such as LDPE, HDPE and polypropylene\*. They also are available in chemistries that don't dissolve in polystyrene plastics or polycarbonate.

\*Primer recommended for low surface energy substrate bonding

### Key Applications

- Leather and rubber bonding
- Shoe assembly
- Sporting goods
- Automotive aftermarket
- Speaker assembly
- Plastic assembly



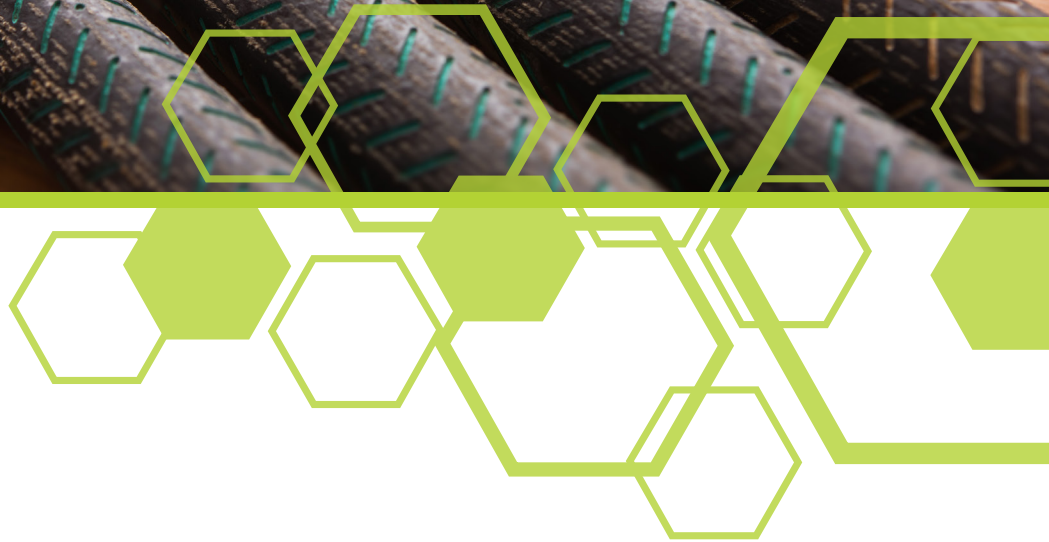
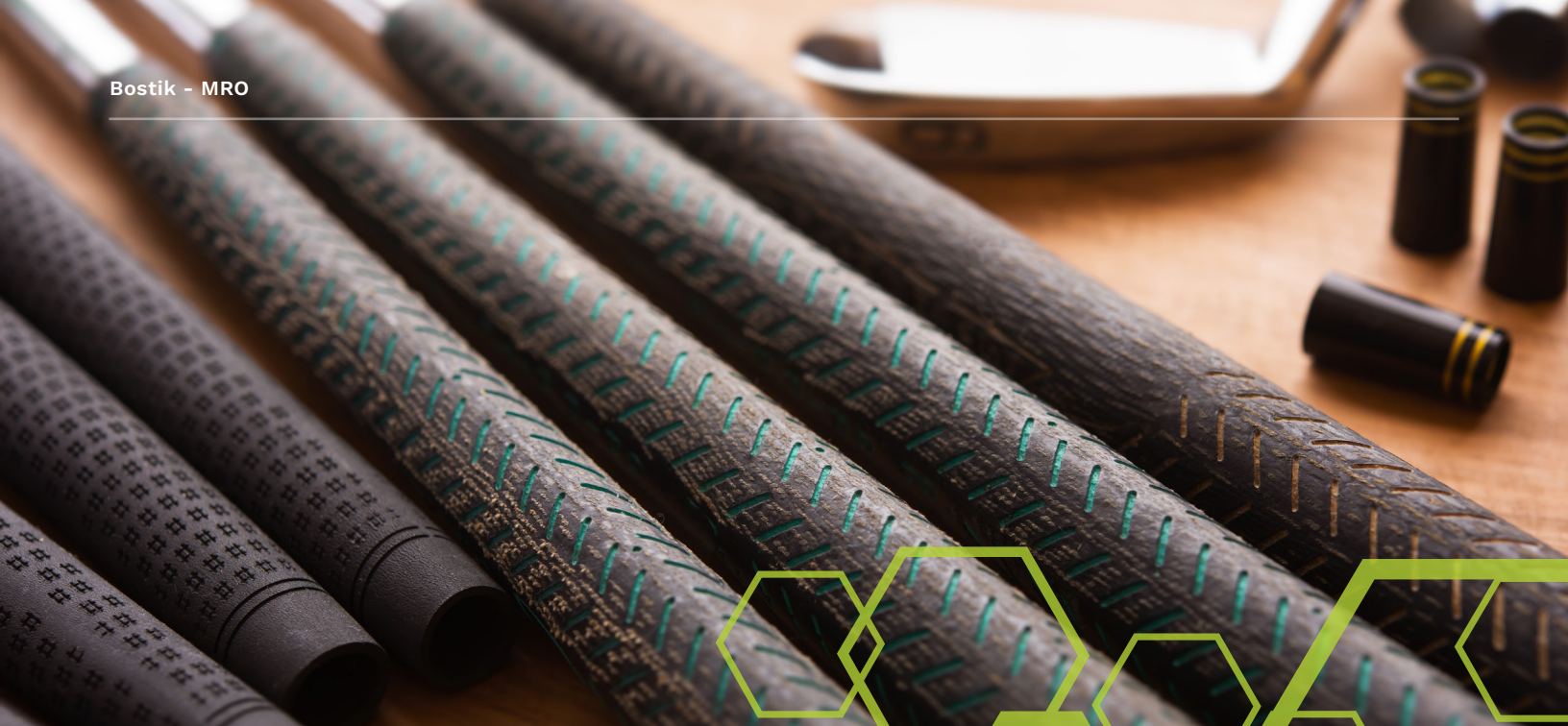

## Best Practices

### BEFORE APPLICATION

Use an alcohol wipe to ensure the substrates are free of contaminants.

Ensure the substrates do not have any gaps between them.

Use a **Born2Bond™ primer** with a low surface energy substrate to increase bond strength and spraying a **Born2Bond™ booster** if looking to speed up fixture time on substrates like woods and plastics.

Check that the primer and booster are dry before applying the adhesive. It should take a few seconds.

### DURING APPLICATION

Avoid leaving the LV, MV and HV bottles open for too long, as moisture can reduce the shelf life of the product.

To help ensure the bond and aid in curing, apply consistent pressure (ideally via clamps) for the given fixture time depending on the substrate. Refer to product TDS for specific fixture time per substrate.

### AFTER APPLICATION

Let the substrates set for 24 hours before testing to ensure proper cure.

Wipe the exterior of the applicator nozzle to remove excessive glue buildup.

### PROPER STORAGE:

For best results, keep products refrigerated.

# Born2Bond™ Structural, Repair and Flex

## Structural

Born2Bond™ Structural is a patented, high-strength hybrid adhesive that provides a fast fixture time at room temperature while maintaining good processability. It bonds gaps up to 5mm and offers excellent bonding characteristics to aluminum, steel, plastics (polycarbonate and ABS), woods, chipboards and leathers, which increases design options. It also is non-sagging for precise application.

FEATURES	BENEFITS
High adhesion strength: >870psi after 5 minutes	Improved durability
Hybrid formulation for strength of epoxy yet speed of instant	Increased design flexibility
Transparent when cured	Enhanced aesthetics

## Key Applications

- Structural bonding
- Metal bonding
- Plastic to metal bonding
- Glass to leather bonding
- Wood processing aid

Additionally, Structural works well for applications that require mechanical and in-use environmental resistance.

## Best Practices

### BEFORE APPLICATION

Use an alcohol wipe to ensure the substrates are free of contaminants.

Consider using a **Born2Bond™ primer** with a low surface energy substrate to increase bond strength and spraying a **Born2Bond™ booster** if looking to speed up fixture time on substrates like woods and plastics.

Check that the primer and booster are dry before applying the adhesive. It should take a few seconds.

Purge at least 1 cm to ensure the two parts are completely mixed through the static mixer.

If a 3" gap exists between the two substrates, allow for a longer than normal cure time, and keep the substrates in place during it with a clamp.

### AFTER APPLICATION

Let the substrates set for 24 hours before testing to ensure proper cure.

### PROPER STORAGE:

For best results, keep products refrigerated.





## Repair

Born2Bond™ Repair offers high-impact resistance and excellent adhesion to a very broad range of materials and surfaces, such as woods and plastics. Additionally, Repair helps with fast aftermarket repair needs, because it combines the strength of a structural adhesive with the speed of an instant adhesive. It is non-sagging for precise application.

FEATURES	BENEFITS
Low volume shrinkage: ~4%	Unlimited gap-filling capabilities
Machinable, sandable and paintable once hardened	Enhanced aesthetics overall
Fixture time in 60 seconds*	Increased operational efficiencies

\*Depending on gaps and substrates

## Key Applications

- **Automotive aftermarket: quick bumper repair**
- Wood repair and reconstruction
- Rubber and automotive joint bonding
- Plastic defect repairing

## Best Practices

### BEFORE APPLICATION

Use an alcohol wipe to ensure the substrates are free of contaminants.

Consider using a **Born2Bond™ primer** with a low surface energy substrate to increase bond strength and spraying a **Born2Bond™ booster** if looking to speed up fixture time on substrates like woods and plastics.

Check that the primer and booster are dry before applying the adhesive. It should take a few seconds.

Purge at least 1 cm to ensure the two parts are completely mixed through the static mixer.

### DURING APPLICATION

If a gap exists between the two substrates, allow for a longer cure time, and keep the substrates in place during it.

### AFTER APPLICATION

Wait about 15 mins before sanding and/or painting to ensure enough time for proper cure.

### PROPER STORAGE:

For best results, keep products refrigerated.

## Flex

Born2Bond™ Flex offers very good adhesion to a variety of materials, such as metals, woods and plastics, as well as porous and irregular surfaces. Once hardened, it has over 200% elongation and a working time of up to six minutes in a mixer for high-volumetric gap filling needs. It also is non-sagging for precise application.

FEATURES	BENEFITS
Absorbs impacts and vibrations	Increased durability
High peel strength	Improved process flexibility
Formulated with gel consistency	Enhanced precise application abilities
Extensive elongation	Extended resistance

## Key Applications

- Luxury clothing leather bonding
- Sealing repair
- Elastic seam and joint sealing
- Floor and panel bonding
- Glass to rubber bonding

## Best Practices

### BEFORE APPLICATION

Use an alcohol wipe to ensure the substrates are free of contaminants.

Consider using a **Born2Bond™ primer** with a low surface energy substrate to increase bond strength and spraying a **Born2Bond™ booster** if looking to speed up fixture time on substrates like woods and plastics.

Check that the primer and booster are dry before applying the adhesive. It should take a few seconds.

Purge at least 1 cm to ensure the two parts are completely mixed through the static mixer.

### DURING APPLICATION

If a gap exists between the two substrates, allow for a longer cure time, and keep the substrates in place during it.

### AFTER APPLICATION

Let the substrates set for 24 hours before testing to ensure full cure.

### PROPER STORAGE:

For best results, keep products refrigerated.

# Dual Cure: Born2Bond™ Light Lock (MV, HV and Gel)

Born2Bond Light Lock MV, HV and Gel are designed for applications that require fast fixturing, coating or surface cures. With UV and visible light curing capabilities, these products offer fast bonding for transparent parts or light-exposed bulk and surface-coated areas. Unlike many other light-curing technologies, Light Lock products have a dual-cure mechanism that will ensure full curing between opaque surfaces without use of the light. Squeeze-out also can be cured at a part's edges using the light to minimize cleanup.

FEATURES	BENEFITS
Fixture time* in 60 seconds without light exposure, 5 seconds with light curing	Increased application speeds
Bonds, fills, reconstructs and coats	Enhanced versatility
Long open time without activation	Improved process flexibility

\*Depending on gaps, substrates and ambient conditions

## Key Applications

- Electronics assembly
- Encapsulation
- Glass, metal and plastic bonding
- Conformal coating

## Best Practices

### BEFORE APPLICATION

Use an alcohol wipe to ensure the substrates are free of contaminants.

Consider using a **Born2Bond™ primer** with a low surface energy substrate to increase bond strength and spraying a **Born2Bond™ booster** if looking to speed up fixture time on substrates like woods and plastics.

Check that the primer and booster are dry before applying the adhesive. It should take a few seconds.

### DURING APPLICATION

Avoid leaving the LV, MV and HV bottles open for too long; moisture can reduce the shelf life of the product, and exposure to light can cause the product inside the bottle to cure.

To help ensure the bond and aid in curing, apply consistent pressure (ideally via clamps) for the given fixture time depending on the substrate. Refer to product TDS for specific fixture time per substrate.

### AFTER APPLICATION

Let the substrates set for 24 hours before testing to ensure proper cure.

Wipe the exterior of the applicator nozzle to remove excessive glue buildup.

### PROPER STORAGE:

For best results, keep products refrigerated.



# How to Choose the Right Instant Adhesive

Please use the Product Selector below to identify the right solutions for your bonding requirements.

	PRODUCT PRE-SELECTOR		
	1K	2K	DUAL CURE
<b>GAP FILLING</b>	< 0.15mm	Up to centimeters	< 10mm*
<b>FIXTURE TIME</b>	5 - 15 sec	> 15 sec	< 5 sec*
<b>OPEN TIME</b>	+++	++	++
<b>IMPACT RESISTANCE</b>	+	+++	++

DEFINITIONS	
<b>GAP FILLING</b>	Dispensing or injecting a one or two-component curing system, resulting in a soft or structural form-in-place elastomer or polymer, used as an adhesive, sealant or to fill a void.
<b>FIXTURE TIME</b>	Time taken to obtain a level of performance sufficient to hold a load with 1kg weight for 10 seconds.
<b>OPEN TIME</b>	Time during which one can assemble the two parts of an assembly and obtain the maximum properties.
<b>IMPACT RESISTANCE</b>	Ability to withstand intense force or shock applied to it over a short period of time. Impact resistance is an important consideration for fall protection equipment.

\* For light curing

+ Moderate ++ Good +++ Excellent

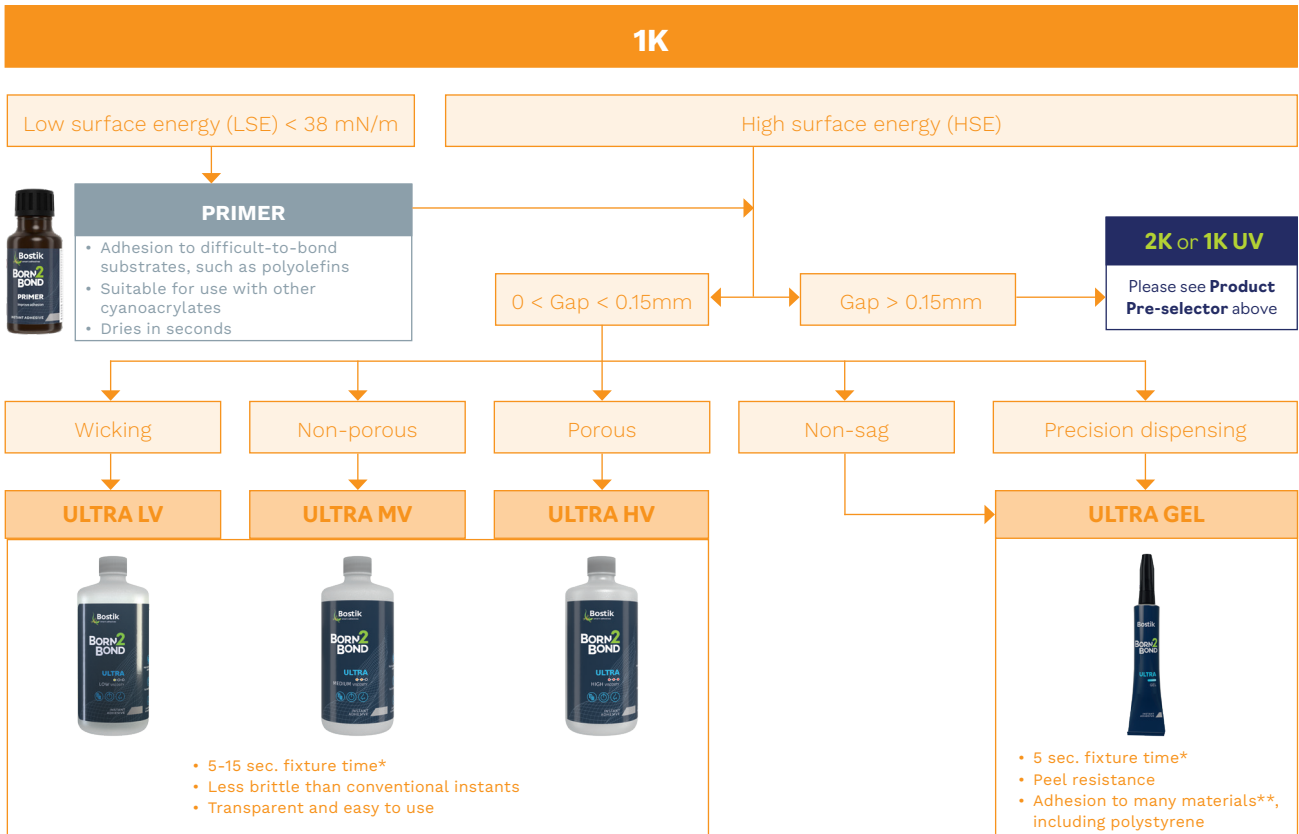

\*Depending on gaps and substrates \*\*Except polyolefins

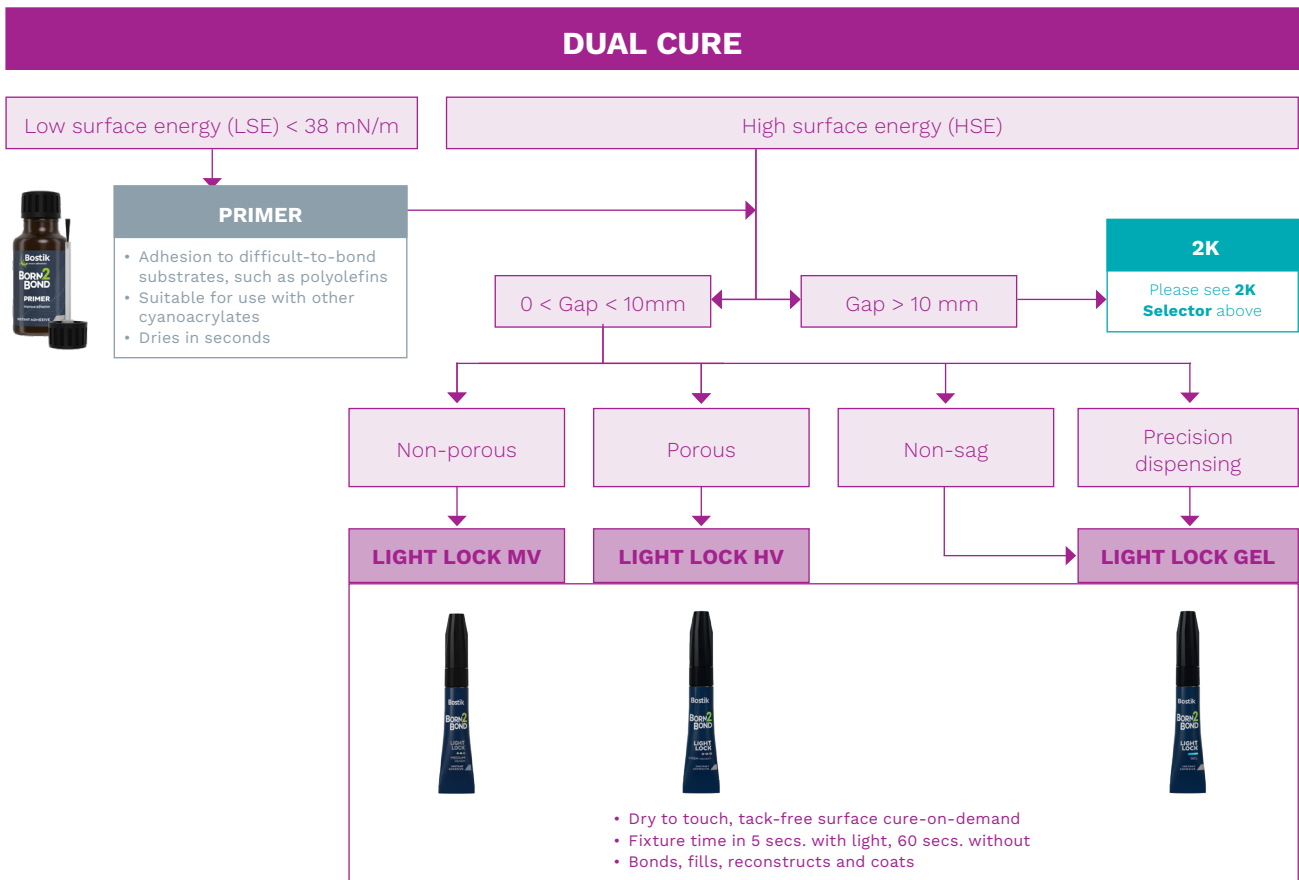
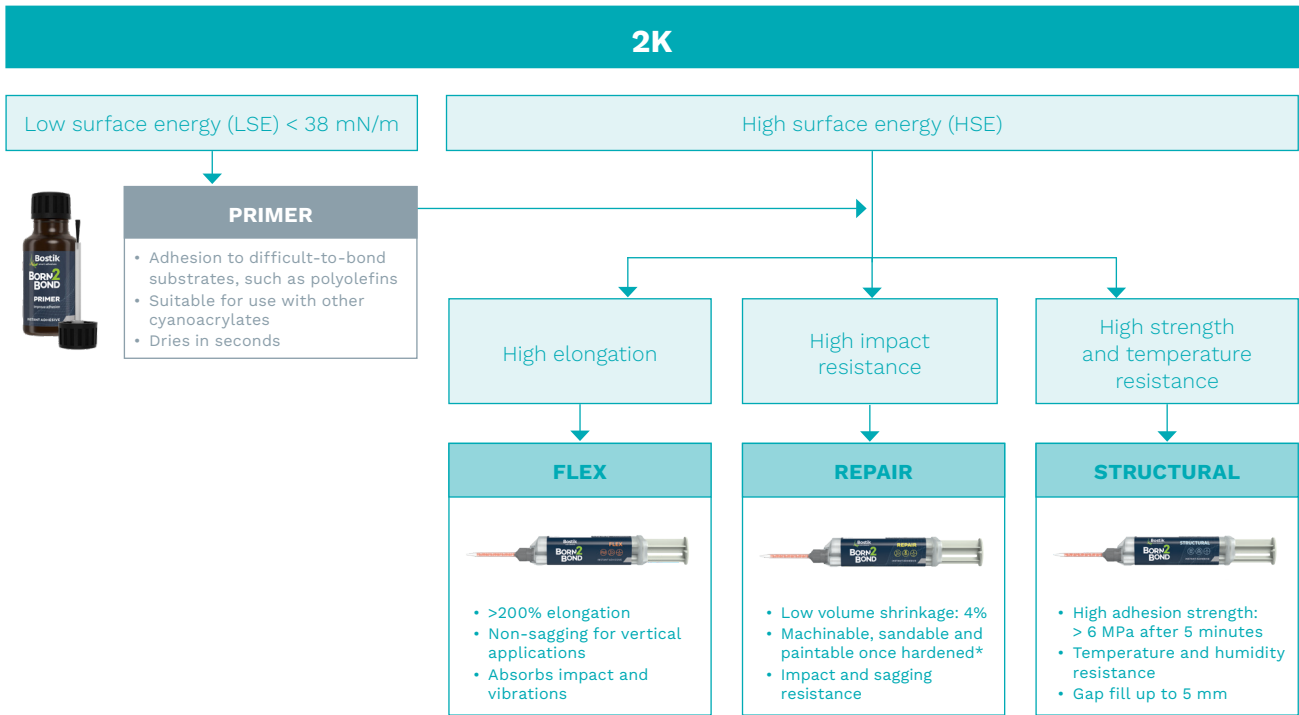

**For more product information on our MECA-based instants, visit [born2bond.bostik.com](http://born2bond.bostik.com).**

# General Bonding

Bond a variety of substrates with ease

## Aerosol Adhesives

Bostik's SuperTak® general purpose and high-performance grade aerosol adhesives are compliant with federal and local VOC standards. Packaged in easy-to-use, handheld cans, they make it simple to achieve different spray patterns depending on coverage and bonding needs.

FEATURES	BENEFITS
Fine mist (general purpose) and controlled lace (high-performance grade) spray pattern capabilities	Increased application flexibility
Forms odorless bondline	Improved worker comfort
Ability to bond a variety of substrates, including low energy plastics	Enhanced design options

## Key Applications

### GENERAL PURPOSE

- Pool tables
- Sewing
- Screen printing
- Bonding paper, fabric and fiberglass to itself and to metal and wood

### HIGH PERFORMANCE

- Swimming pool liners
- Installing insulation
- Attaching carpet, door skins and fabric in van conversions
- Forming permanent bonds between porous and nonporous surfaces

## Choosing the Right Aerosol Adhesive

### COVERAGE NEEDS

**General Purpose** produces a fine mist spray pattern, which provides uniform coverage to large areas with low soak-in and no staining or wrinkling to lightweight, porous materials.

**High Performance** yields a controlled lace spray pattern, which provides precise coverage to small areas without overspray to porous and nonporous materials.

### BOND TIME REQUIREMENTS

#### GENERAL PURPOSE

- 1-surface bond: 1-5 mins.
- 2-surface bond: 1-10 mins.

#### HIGH PERFORMANCE

- 1-surface bond: 4-10 mins.
- 2-surface bond: 8-15 mins.



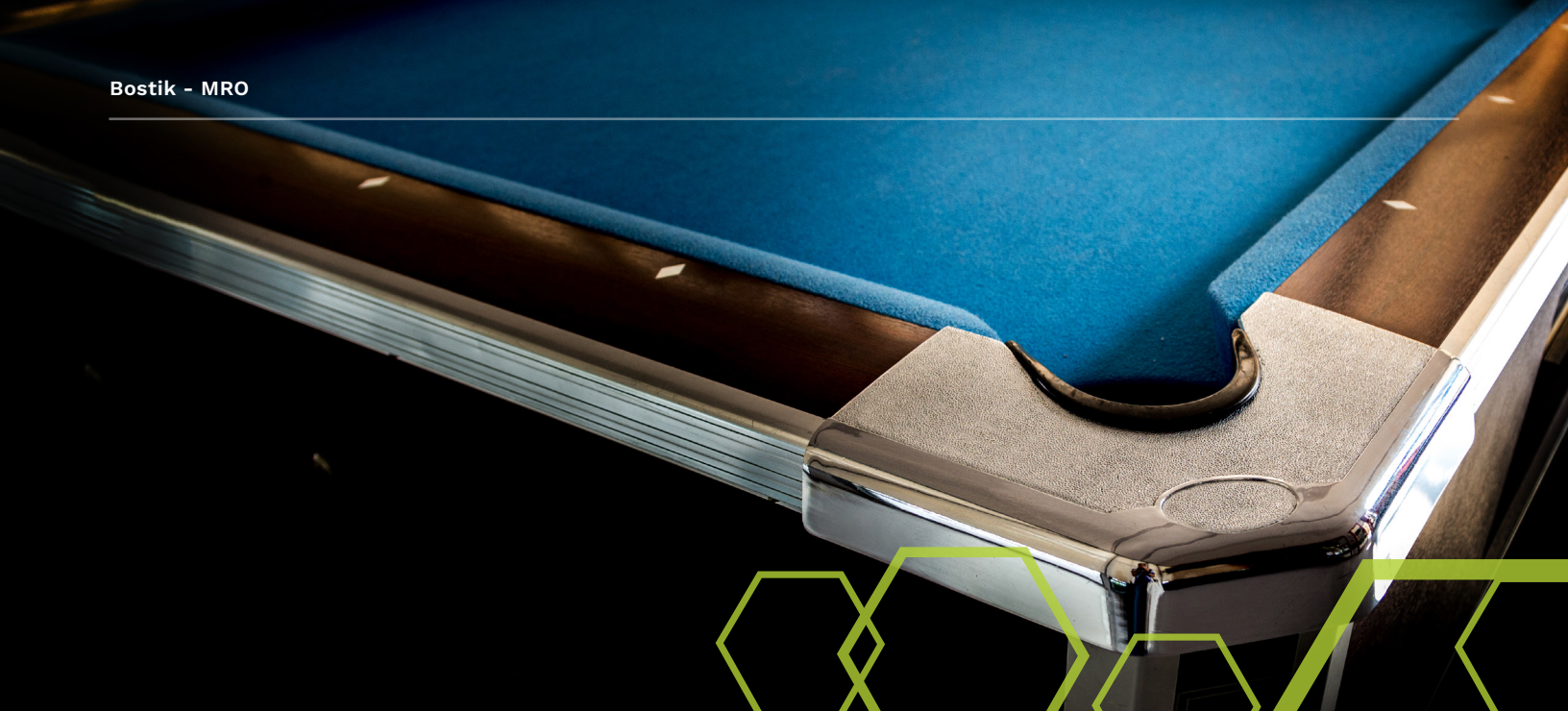

## **Best Practices**

### **BEFORE APPLICATION**

Choose the fine mist pattern to bond large areas; this will result in a thin coat weight.

Choose the controlled lace pattern to bond small areas; this will reduce overspray and result in a heavy coatweight.

### **DURING APPLICATION**

Hold the can's nozzle 4-6" away from the substrate for best application, drying and end-use performance results.

Spray in an even, continuous motion from left to right to ensure uniform coating throughout the area.

## Glue Sticks

Bostik’s glue sticks are based on EVA, polyolefin and polyamide technologies and available in small or bulk quantities. They require a glue gun to apply, such as Bostik’s TG-560 gun, and can accommodate a ½” – 7/16” diameter. These glue sticks also possess application-specific qualities and can be used in applications requiring certifications, such as NSF61 for drinking water. They also have OEM approval for flame retardant, aerospace applications.

FEATURES	BENEFITS
Variety of chemistries and viscosities	Increased substrate bonding capabilities, such as to difficult-to-bond, low energy plastics, including polyethylene and polypropylene
Low color options	Improved aesthetic options
Range of melting temperatures for high and low temperature performance	Enhanced ability to bond temperature-sensitive substrates, such as Styrofoam
Chemical and oil resistance	Heightened durability

## Key Applications

- Case and carton sealing
- Potable water filtration
- Applications and white goods
- Automotive interior trim components
- Dispensing

## Choosing the Right Glue Stick

Product	Color	Open Time	ABS & Similar Plastics	Leather & Vinyl	Glass & Ceramics	Low-Temp. Foams	Cardboard Packaging	Polyolefins	General Purpose	Plywood/ Particle Boards	Solids/ Hard Woods
6327	Colorless	30 secs.							●		
6239	Amber	75 secs.		●							
2109	Tan	10-30 secs.					●				
6305	Pale straw	3-8 secs.					●				
6368	Light amber	5-10 secs.									
0130	Colorless	30+ secs.	●								
2124	Colorless	30+ secs.			●						
0720	Colorless	10-30 secs.				●					
6363	Off white	40 secs.			●						
6390	Light straw	75 secs									●
2109	-	-								●	●



## Best Practices

Ensure the surfaces are free from contaminants and that the glue gun heats up for 5 minutes before application.

Glue sticks are available with 10 – 40 seconds or more of open time. Select the glue stick based on the amount of working time needed for your application.

Likewise, choose the glue stick temperature resistance in accordance with your application temperature.

When bonding dissimilar substrates such as wood and glass or plastic and glass, apply the glue stick to the least temperature-sensitive substrate first.

# Structural Bonding

Create high strength bonds between two substrates

Known as Pliogrip™, Bostik's structural adhesive systems are based on epoxy, acrylic and polyurethane chemistries. Ideal for side and panel bonding, they work well on metals, plastics and composites and serve as an easy alternative to welding threaded fasteners and rivets without sacrificing performance. These adhesives are available in both hand-held and pneumatic applications and can be sanded in a short time while maintaining property balances.

## Structural Epoxy Adhesives

FEATURES	BENEFITS
Bare metal bonding	Eliminates protective coating need
Excellent chemical and impact resistance	Increases durability and longevity

## Structural Acrylic Adhesives

FEATURES	BENEFITS
Little to no surface preparation with room-temperature cure	Simplifies production steps
High strength bonding	Eliminates need for mechanical fasteners
Low bond line read-through	Minimizes surface distortion

## Structural Polyurethane Adhesives

FEATURES	BENEFITS
High sag resistance and good elasticity	Enables precision bonding capabilities and flexibility
Imperceptible shrinkage	Enhances dimensional stability
Excellent heat acceleration and wide fixture time range	Increases productivity and process option variety

## Key Applications

- Sign bonding
- Metal bonding
- Plastic bonding



## Choosing the Right Structural Adhesive

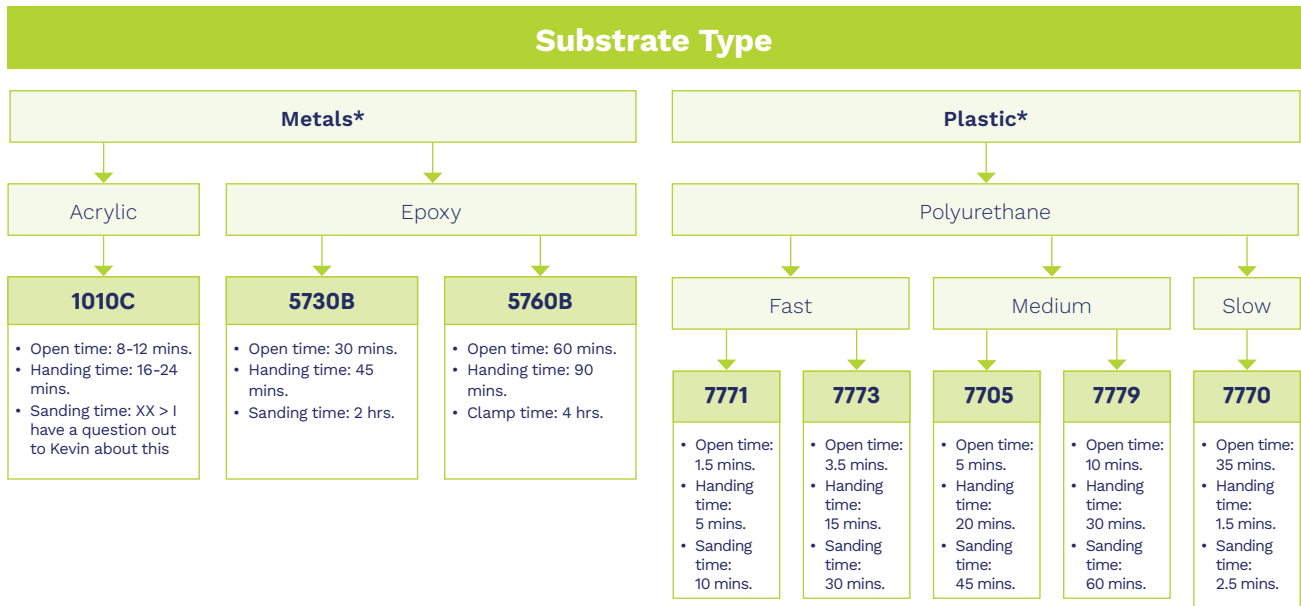

\* While all chemistries can bond to either metals or plastics, the above chart shows our recommended selection approach. All times are based on 73°F (23°C).

## Best Practices

### BEFORE APPLICATION

For high strength structural bonds, remove surface contaminants such as paint, oxide films, oils, dust, mold release agents and all other surface contaminants. We recommend using Bostik Pre-Bond Cleaner to remove these contaminants.

Use gloves to minimize skin contact. DO NOT use solvents for cleaning hands.

### DURING APPLICATION

For dual cartridges: To begin using a new cartridge, remove cartridge cap and dispense a small amount of adhesive, making sure both parts A&B are extruding. Attach nozzle and dispense approximately 25 to 50mm before applying onto part to be bonded.

**DID YOU KNOW?** Partially-used cartridges can be stored with the mixing nozzle attached. To reuse, remove and discard the old nozzle, first attach the new nozzle and then dispense approximately 25 to 50mm before applying onto part to be bonded.

For maximum bond strength, apply adhesive evenly to both surfaces that need to be joined. Ensure application to the substrates is made as soon as possible. Larger quantities and/or higher temperatures will reduce the working time.

Join the adhesive coated surfaces and allow to cure. Higher temperatures will speed up curing.

Keep assembled parts from moving during cure. The bond should be allowed to develop full strength before subjecting to any service load.

### DURING APPLICATION

Clean any excessive, uncured adhesive with ketone type solvents.

# Service Products

Ensure effective bonding, cutting and threaded fastening to avoid manufacturing delays

## Surface Preparation

Bostik's line of Born2Bond™ service products are designed to help manufacturers achieve ideal bond strength in minimal time, especially when used in conjunction with our compatible Born2Bond instant and anaerobic adhesives. This product line entails:

### Pre-Bonding Cleaner

Solvent-based and supplied in aerosol form, our pre-bonding cleaner removes grease, oil, lubricants and other contaminants without leaving any residue.

FEATURES	BENEFITS
Fast evaporation	Streamlined operational efficiencies
Multi-substrate adhesion, including sensitive plastics	Enhanced design options
No residue left behind	Increased aesthetics

### Key Applications

- Metal and plastic parts
- Composite materials
- Flanges
- Bolts
- Shafts

### Best Practices

Spray the product from 15-20cm away from the surface. If standing closer, use a solvent-soaked towel to wipe away excess.

Use a cannula if high precision is required.

After spraying, wipe with a clean paper towel in one direction to remove contaminants.

Wait until the solvent has evaporated before bonding.



## Activator

Bostik’s Born2Bond anaerobic activator is a solvent-based product that accelerates and supports anaerobic adhesive curing on passive metals, like stainless steel, chromated metals and zinc, as well as in cold temperatures. It can also expedite the cure speed for large gaps and increase bond strength overall.

FEATURES	BENEFITS
Fast evaporation (30 secs. – 1 min.)	Streamlined operational efficiencies
Can be used at low temperatures (<41°F/5°C)	Increased application uses
On-part, 30-day lifetime	No need to reapply once sprayed

## Key Applications

- Stainless steel bolts and shafts
- Threadlocking
- Pipe sealing
- Gasketing
- Retaining

## Best Practices

### BEFORE APPLICATION

Ensure the surface is clean, dry and grease-free. Use the **Born2Bond™ pre-bonding cleaner** if bonding contaminated surfaces to eliminate contaminants.

### DURING APPLICATION

In case of small gaps, spray the activator on both mating surface to achieve sufficient adhesion.

Assemble the substrates immediately after spraying.

### AFTER APPLICATION

Wait a few minutes before handling the parts to give the solvent time to evaporate (30 secs. – 2 mins.)

This product will last on parts for up to 7 or 28 days.



## Booster

Bostik’s Born2Bond™ Booster accelerates cyanoacrylate curing for acidic woods and porous substrates especially. Its long open time and short drying time help keep assembly lines moving. Additionally, unlike other products of its kind, Booster promotes quick adhesion to parts immediately subjected to high stress, such as edge coating or shoe soles.

FEATURES	BENEFITS
Dries in seconds	Streamlined operational efficiencies
24-hour open time	Increased manufacturing flexibility
Transparent	Enhanced aesthetics

## Key Applications

- Surface preparation
- Bond acceleration for wood, leather and vertical surfaces

## Best Practices

### BEFORE APPLICATION

Ensure the surface is clean, dry and grease-free.

### DURING APPLICATION

Apply Booster to one surface and allow the product to completely dry before moving on, typically in 5-10 seconds. However, if working with low ambient humidity, it can slow the cure.

### AFTER APPLICATION

Once dry, apply the adhesive and assemble the parts within sections.





## Primer

Bostik’s Born2Bond™ Primer helps low surface energy substrates, such as polyolefins, be suitable for bonding with cyanoacrylates. It can be applied at room temperature via brushing for ease of use. However, manufacturers should only use this on difficult-to-bond substrates, including polyethylene, polypropylene, polytetrafluoroethylene and thermoplastic rubbers. It also is not recommended in assemblies where high peel strength is required.

FEATURES	BENEFITS
Dries in seconds	Streamlined operational efficiencies
Increases adhesion strength	Enhanced end-use performance
Suitable for use with other cyanoacrylates	Improved compatibilities

## Key Applications

- Surface preparation
- Bonding difficult-to-adhere plastics and polyolefins

## Best Practices

### BEFORE APPLICATION

Ensure the surface is clean, dry and grease-free.

### DURING APPLICATION

Ensure to use only the proper amount of primer on the substrate.

Apply the primer to the polyolefin, if using a polyolefin to bond the surfaces together.

### AFTER APPLICATION

Ensure the surface is fully dry before applying the adhesive to one of the surfaces, and then assemble the part within seconds after adhesive application.



## Adhesive and Gasket Remover

Bostik's Born2Bond™ Adhesive and Gasket Remover forms a foam-like layer around old gaskets and cured adhesives to make them easily removable within 15 minutes. Yielding minimal damage to flanges and surfaces, it is ideal for cleaning various substrates (metal, wood, glass, ceramics, polyethylene and polypropylene), gearboxes, metal housings and pumps.

FEATURES	BENEFITS
Fast evaporation	Improved operational efficiencies
Multi-substrate adhesion	Increased uses

### Best Practices

Once the bottle is shaken, spray from a distance of approx. 15-25cm on the surface needing treatment.

For high precision, use the cannula.

Wait 5 to 10 mins. after applying so that the product can work itself into the surface.

Remove with industrial wipe (use a scraper if needed).

# Surface Preparation

Bostik's aerosol lubricants, GlideCote™ and BladeCote™, are designed specifically for secondary woodworking applications and do not interfere with coating or finishing needs. Unavailable anywhere else on the market, they are formulated in conveniently-sized, handheld cans to make it easy for manufacturers' on-the-job needs.

## GlideCote and BladeCote

FEATURES	BENEFITS
Less friction	Increased ease to slide wood, no blade-burn or discoloration
No impact on stain, paint or wood finish	Improved aesthetics
Do not attract dust or dirt	Less cleanup, better cosmetics

## BladeCote Only

FEATURES	BENEFITS
Decrease resin buildup and friction	Reduced blade maintenance cost and energy usage, prolonged blade life

## Key Applications

- Saw blades (BladeCote)
- Table saws (GlideCote)

## Choosing the Right Lubricant

- For sliding wood > GlideCote
- For cutting wood > BladeCote

## Best Practices

Keep the products separate (i.e., no mixing) to ensure each product is able to offer full effectiveness.

### GLIDECOTE

Spray two coats for optimal friction reduction and buff lightly.

### BLADECOTE

After several cuts, re-spray BladeCote over entire bit or blade. Re-apply daily or more frequently based upon workload and material being cut.





# Anti-Seize Compounds

Bostik’s line of anti-seize compounds, Never-Seez<sup>®</sup>, is the original anti-seize product. Setting the MRO industry standard for over 50 years, these products enable manufacturers to easily assemble and disassemble threaded connections in any industrial environment. In addition to being of high purity and precision formulated, Never-Seez products are qualified to specifications in key markets, such as aerospace and nuclear power. They also are available in multiple point-of-use packaging types, including brush top cans, pipettes, drums and cartridges, to make it easy for manufacturers to choose the option that works best for their application needs.

FEATURES	BENEFITS
Protects from seizures at high temperatures	Extended service life and non-destructive disassembly
Prevents galling	Reduced scrap cost and disassembly time
Resists galvanic action	Increased operational efficiencies

## Key Applications

- Nuts, bolts, screws
- Pipe fittings
- Valve assemblies
- Shafts, gaskets, machinery
- Press fit assemblies

## Choosing the Right Anti-Seize Compound

When choosing the right anti-size compound, manufacturers will want to think about end-use application needs, as some products have certain limitations and specifications.

For specific product grades and their uses, refer to the chart on the following page.

## Best Practices

Apply Never-Seez to the base of the threads, the bolt cap and bolt head to allow for maximum tightening with the least amount of torque.

Ensure the base of the threads are fully covered; there is no need to cover the entire length of the threads.

Screw the nut on the bolt all the way up the shaft to achieve proper coverage for effective lubrication. Then, unthread it off to fill in the anti-seize between the bolt and threads.

Watch this video for an easy-to-follow demonstration

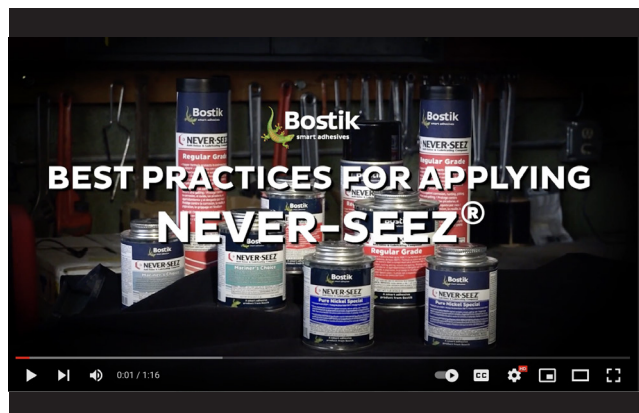



# Product Application Guide

Product	Torque Reduction (Anti-Seize Abilities)	Temperature Levels	Chemical Resistance	Fresh/Salt Water Corrosion Resistance	Aluminum/ Soft Metals	For Use On			Special Formulations	Low Speed/ High Load	High Purity*
						Carbon Steel	Stainless Steel				
Regular Grade	●●	1600 - 1800°F	●	●●	●●	●●	●●	●●	N/A	●●	●●
Pure Nickel Special	●●	2000 - 2400°F	●●●	●	●	●●●	●●●	●●●	Copper Free	●	●●
Black Moly	●●	-150 - 1500°F	●●●	●	●	●	●	●	Copper & Graphite Free	●	●
Blue Moly	●	10 - 750°F	●	●	●	●	●	●	Metal Free	●●●	●
High Temp Stainless	●●	2000 - 2400°F	●●●	●	●	●	●	●	Copper Free	●	●●
Mariner's Choice	●●●	2000 - 2400°F	●	●●●	●●●	●●●	●●●	●●●	Copper Free	●●	●
High Temp Bearing Lubricant	●	500 - 1000°F	●	●	●	●	●	●	N/A	●	●
White Food Grade with PTFP	●	-5 - 475°F	●	●	●●	●	●	●	N/A	●	●
Pipe Compound	●●	-50 - 525°F	●	●	●	●	●	●	Copper, Metal & Graphite Free	●	●
Nickel Nuclear Grade	●●	2000 - 2400°F	●●●	●	●	●●	●●	●●	Copper Free	●	●●●
High Temp Stainless Nuclear Grade	●●	2000 - 2400°F	●●●	●	●	●●	●●	●●	Copper Free	●	●●●

● Acceptable ●● Good ●●● Preferred \*Purity is based on content analysis of heavy metals and other trace minerals.

# Born2Bond™ Seez Release

Bostik's Born2Bond Seez Release product uses a thermal freeze shock effect (at -38°F) to loosen rusted, corroded and seized parts within machinery. It diffuses directly into rust by capillary force.

## Best Practices

Clean the parts of loose rust and dirt.

Once the parts are cleaned of loose rust and dirt, spray from approximately 10-15cm away for 5-10 seconds. For high precision, use the cannula.

Release the seized parts with a suitable tool.

Repeat the process if necessary.



# MRO Target Equipment

The following information details where to use our products on key devices for all MRO needs.

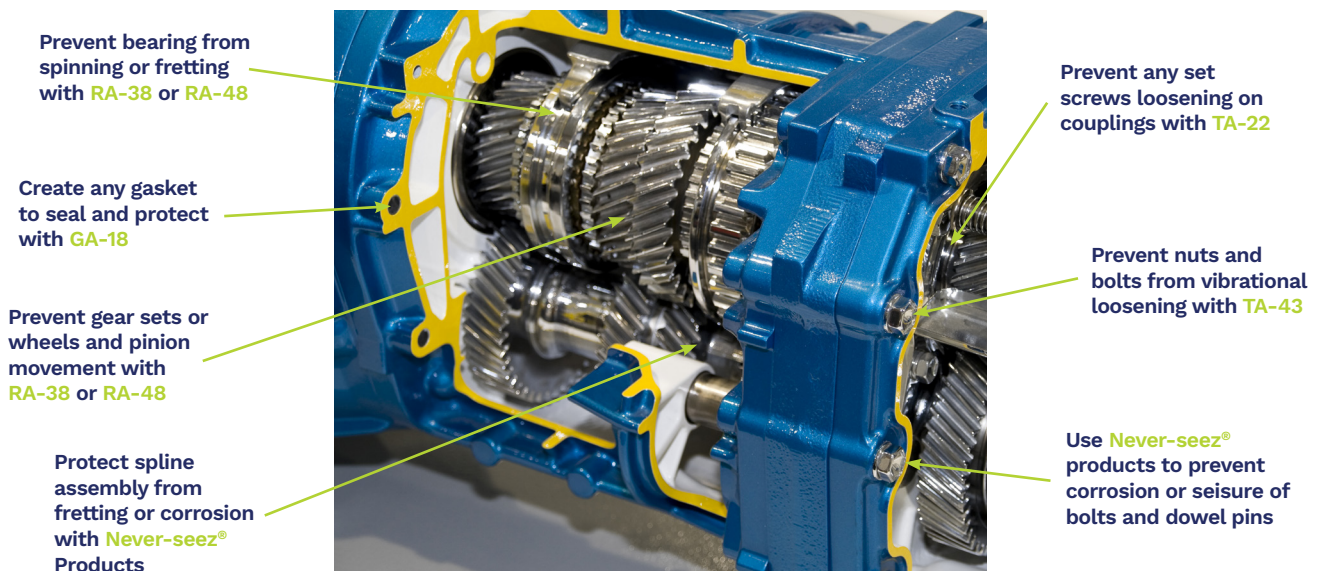
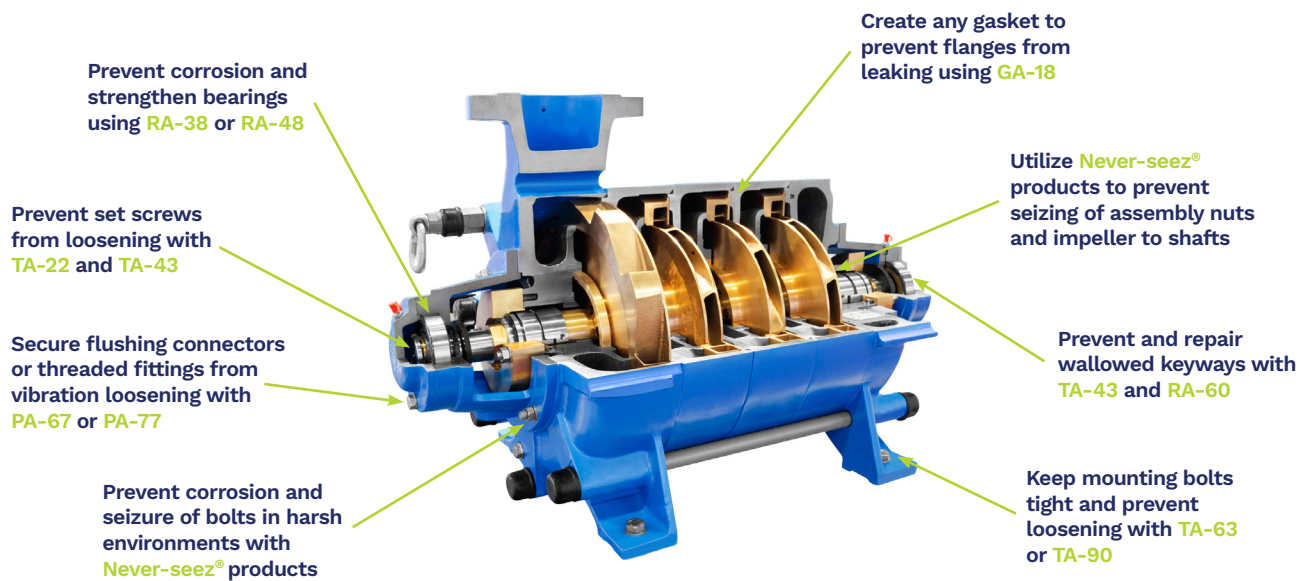

Contact your Bostik expert with any questions

# Distributor Training Resources

At Bostik, we want to ensure our distributors and direct customers know how to best use our MRO products and understand the value they bring. Therefore, we offer MRO solution training resources that include:

- Expert, hands-on training at your site
- Product demonstration videos
- In-person and virtual best practice reviews
- Online training modules and content access
- Demonstration kits

Additionally, we offer “train the trainer” programs for distributors specifically where we detail how to best use our products and teach others how to use them, too.

Distributors and direct customers can take advantages of our technical expertise as well and receive assistance with testing either onsite or at our in-house labs.

By taking advantage of our training resources, you will be able to:





For more  
information on our  
training resources,  
**contact your Bostik  
representative.**





# BOSTIK

## **IMPORTANT – PLEASE READ BEFORE USING THIS BROCHURE TERMS & CONDITIONS**

Bostik offers this Brochure for descriptive and informational use only. The Brochure is not a contract and is not a substitute for expert or professional advice.

The statements, technical information, data, and recommendations contained herein are not exhaustive, are believed to be accurate as of the date hereof, and are not warranted in any way. The Brochure relies upon your knowledge and input, and as such, its results are based solely upon the information you provide and the choices that you make. Since the conditions and methods of use of the products and the information referred to herein are beyond our control, Bostik expressly disclaims any and all liability and damages that may arise from any use of the Brochure, the products, the results therefrom, or reliance on the information contained herein, and you hereby agree to waive any and all claims against Bostik relating in anyway thereto.

The Brochure is one of several tools that may be used to help you find the product best suited for your needs. It is used at your own risk, and by using it, you are knowingly accepting and assuming any and all risks associated with its use, recommendations, output and your selections. You are responsible to test the suitability of any product in advance for any intended use. Bostik does not guarantee the reliability, completeness, use,

or function of the Brochure or any recommendations arising therefrom. The data

and information are provided 'AS IS'.

The information provided herein relates only to the specific products designated and may not be applicable when such products are used in combination with other materials or in any process. **Bostik encourages you to read and understand the Technical Data Sheet and the Safety Data Sheet for all products**, which are located on our corporate website.

NO WARRANTY OF FITNESS FOR ANY PARTICULAR PURPOSE OR WARRANTY OF MERCHANTABILITY, EXPRESSED OR IMPLIED, IS MADE CONCERNING THE PRODUCTS DESCRIBED OR THE INFORMATION PROVIDED HEREIN, AND SUCH WARRANTIES ARE HEREBY DISCLAIMED. Bostik disclaims any liability for direct, incidental, consequential, or special damages to the maximum extent allowed by law. Nothing contained herein constitutes a license to practice under any patent, and it should not be construed as an inducement to infringe any patent. You are advised to take appropriate steps to be sure that any proposed use of the products will not result in patent infringement.

**By using this Brochure, you are hereby consenting to the above terms and conditions of use, and you agree to waive certain rights as set forth above.**

05.12.22

©2022 Bostik. All rights reserved.

Adhesive solutions by **ARKEMA**